

Bornier pour tête de raccordement

Ref : 2810

Rev :

DINA Series

Bornier type BOR-AB

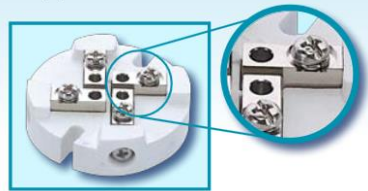

46mm Fixations de 46mm pour accompagner les têtes de raccordement avec code d'identification

Part No.	Poles	Matériel
BOR-AB-2P-C	2	92% AL2O3
BOR-AB-4P-C	4	92% AL2O3

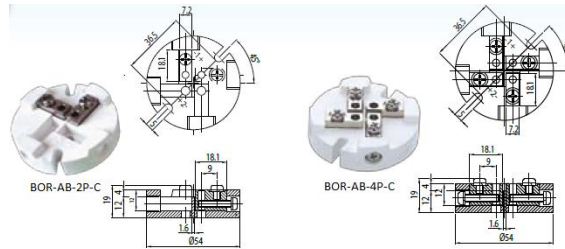

Bornier type BOR-AC



46mm Fixations de 46mm pour accompagner les têtes de raccordement avec code d'identification

Part No.	Poles	Matériel
BOR-AC-2P-C	2	92% AL2O3
BOR-AC-4P-C	4	92% AL2O3

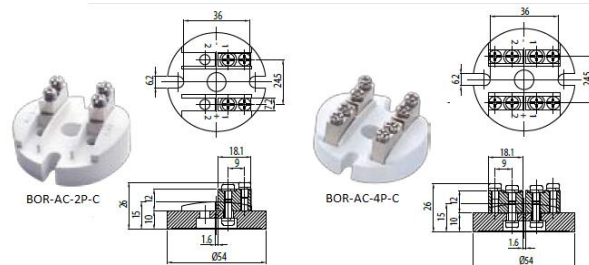

Bornier type BOR-AD

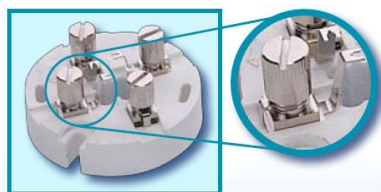

46mm Fixations de 46mm pour accompagner les têtes de raccordement avec code d'identification

Part No.	Poles	Matériel
BOR-AD-2P-C	2	92% AL2O3
BOR-AD-4P-C	4	92% AL2O3

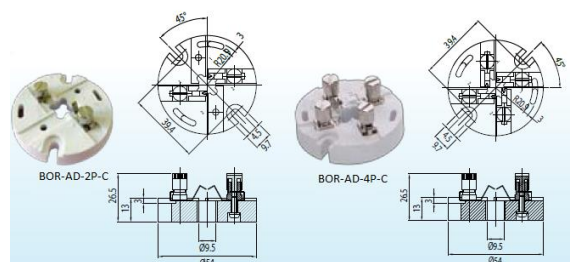

Bornier type ADN

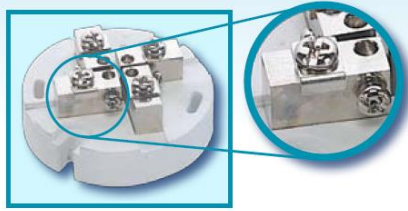

46mm Fixations de 46mm pour accompagner les têtes de raccordement avec code d'identification

Part No.	Poles	Matériel
BOR-ADN-2P-C	2	92% AL2O3
BOR-ADN-4P-C	4	92% AL2O3

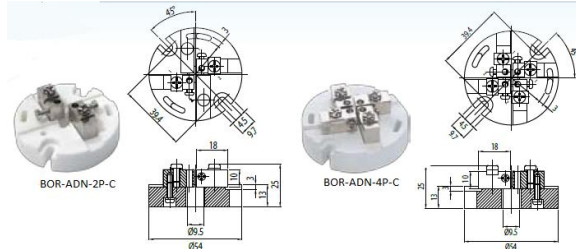

TB series

Bornier type TB

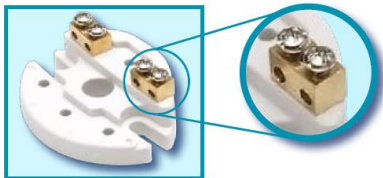

45mm Fixations de 45mm pour accompagner les têtes de raccordement avec code d'identification

Part No.	Poles	Matériel
BOR-TB-2P-C	2	45% AL2O3
BOR-TB-3P-C	3	45% AL2O3
BOR-TB-4P-C	4	45% AL2O3
BOR-TB-6P-C	6	45% AL2O3

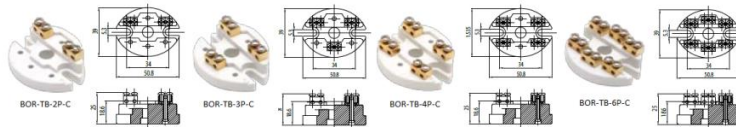

N series

Bornier type N



40mm Fixations de 40mm pour accompagner les têtes de raccordement avec code d'identification

Part No.	Poles	Matériel
BOR-N-2P-C	2	45% AL2O3
BOR-N-3P-C	3	45% AL2O3
BOR-N-3P-C-45	3	45% AL2O3
BOR-N-4P-C	4	45% AL2O3
BOR-N-6P-C	6	45% AL2O3

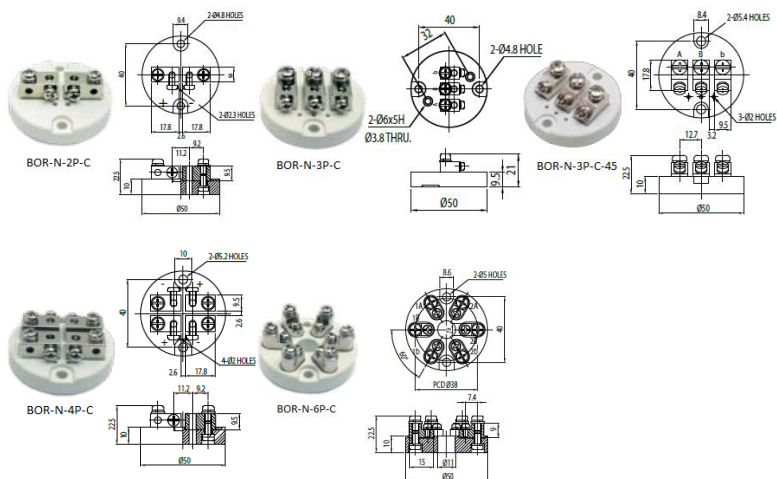

Bornier type N

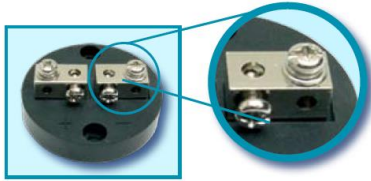

40mm Fixations de 40mm pour accompagner les têtes de raccordement avec code d'identification

Part No.	Poles	Matériel
BOR-N-2P-B	2	Bakelite
BOR-N-3P-B	3	Bakelite
BOR-N-4P-B	4	Bakelite
BOR-N-6P-B	6	Bakelite

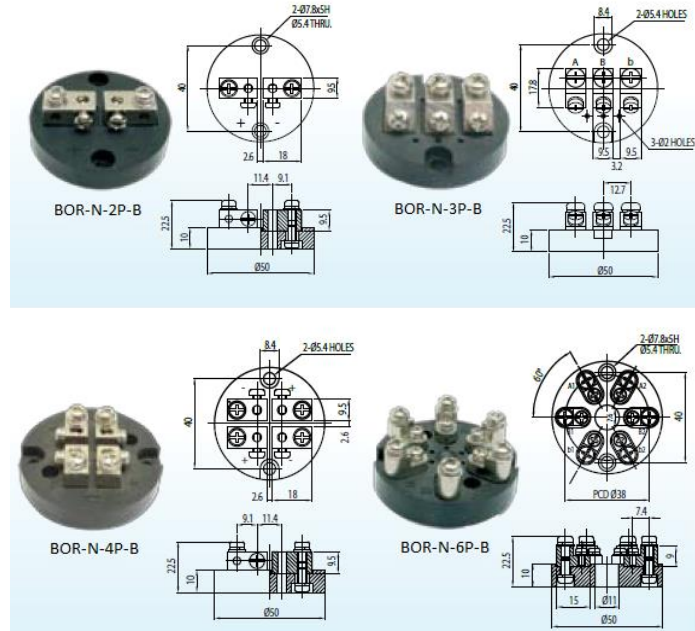

Bornier type N-Y

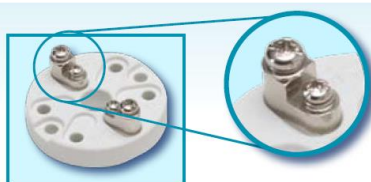

40mm Fixations de 40mm pour accompagner les têtes de raccordement avec code d'identification

Part No.	Poles	Matériel
BOR-N-2P-C-Y	2	45%Al203
BOR-N-3P-C-Y	3	45%Al203
BOR-N-4P-C-Y	4	45%Al203
BOR-N-2P-B(H)	2	Bakelite
BOR-N-3P-B-Y	3	Bakelite
BOR-N-4P-B-Y	4	Bakelite

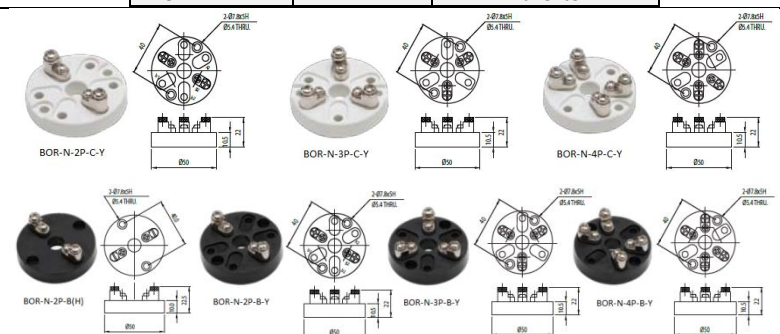

M Series

Bornier de type M (vis)

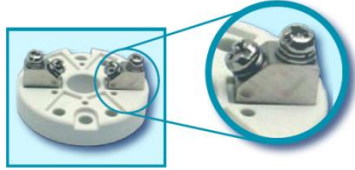

33mm Fixations de 33mm pour accompagner les têtes de raccordement avec code d'identification

Part No.	Poles	Matériel
BOR-M-2P-C	2	45%Al203
BOR-M-3P-C	3	45%Al203
BOR-M-4P-C	4	45%Al203
BOR-M-6P-C	6	45%Al203

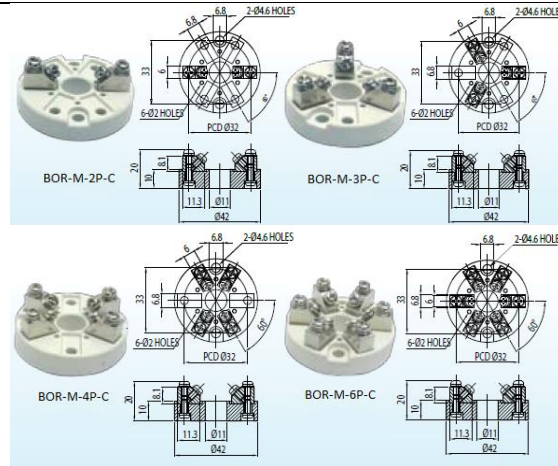

Bornier de type MC (vis avec attache)

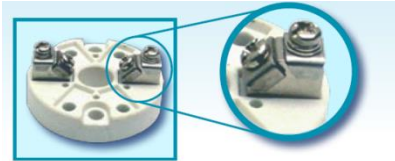

33mm Fixations de 33mm pour accompagner les têtes de raccordement avec code d'identification

Part No.	Poles	Matériel
BOR-MC-2P-C	2	45%Al203
BOR-MC-3P-C	3	45%Al203
BOR-MC-4P-C	4	45%Al203
BOR-MC-6P-C	6	45%Al203

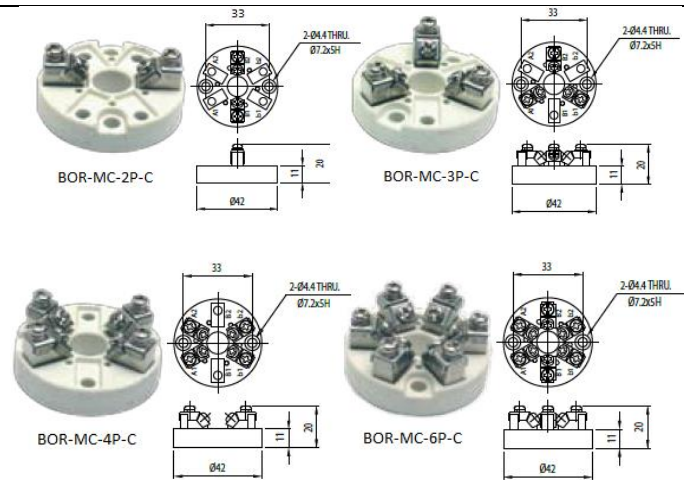

Bornier de type MD

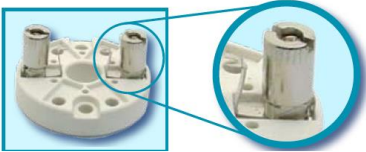

33mm Fixations de 33mm pour accompagner les têtes de raccordement avec code d'identification

Part No.	Poles	Matériel
BOR-MD-2P-C	2	45%Al203
BOR-MD-3P-C	3	45%Al203
BOR-MD-4P-C	4	45%Al203
BOR-MD-6P-C	6	45%Al203

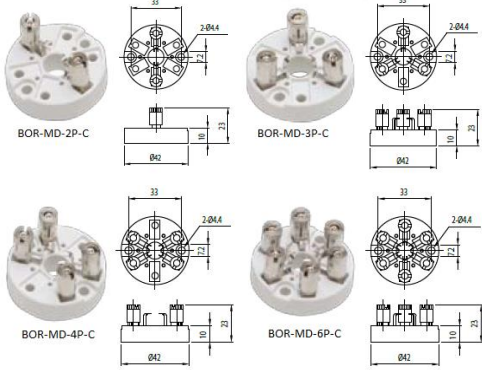

Bornier de type MN



33mm Fixations de 33mm pour accompagner les têtes de raccordement avec code d'identification

Part No.	Poles	Matériel
BOR-MN-2P-C	2	45%Al203
BOR-MN-3P-C	3	45%Al203
BOR-MN-4P-C	4	45%Al203

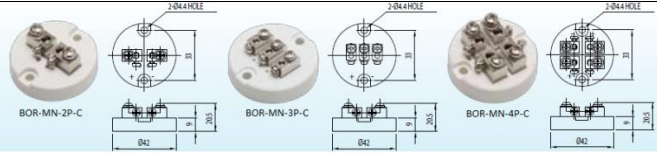

DB Series

Bornier de type DB



33mm Fixations de 33mm pour accompagner les têtes de raccordement avec code d'identification

Part No.	Poles	Matériel
BOR-DB-2P-C	2	45%Al203
BOR-DB-3P-C	3	45%Al203
BOR-DB-4P-C	4	45%Al203
BOR-DB-6P-C	6	45%Al203
BOR-DB-8P-C	8	45%Al203

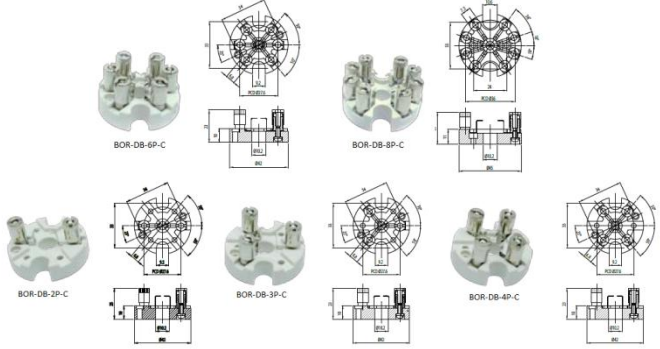

Bornier de type DBS

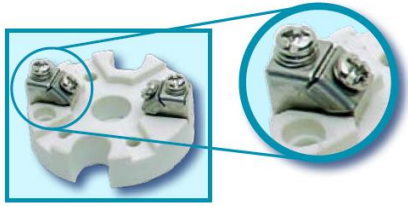

33mm Fixations de 33mm pour accompagner les têtes de raccordement avec code d'identification

Part No.	Poles	Matériel
BOR-DBS-2P-C	2	45%Al203
BOR-DBS-4P-C	4	45%Al203
BOR-DBS-6P-C	6	45%Al203

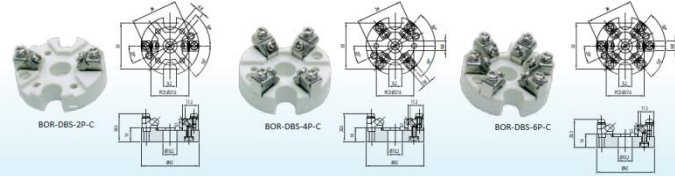

DL&DN Series

Bornier de type DL

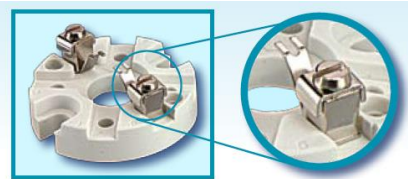

33mm Fixations de 33mm pour accompagner les têtes de raccordement avec code d'identification

Part No.	Poles	Matériel
BOR-DL-2P-C	2	92%Al203
BOR-DL-3P-C	3	92%Al203
BOR-DL-4P-C	4	92%Al203
BOR-DL-6P-C	6	92%Al203

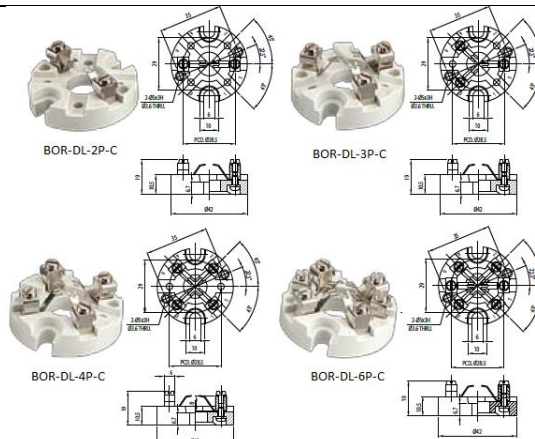

Bornier de type DN

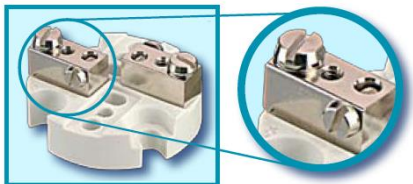

33mm Fixations de 33mm pour accompagner les têtes de raccordement avec code d'identification

Part No.	Poles	Matériel
BOR-DN-2P-C	2	45%Al203
BOR-DN-4P-C	4	45%Al203

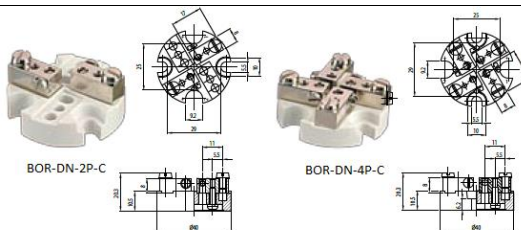

D Series

Bornier de type D

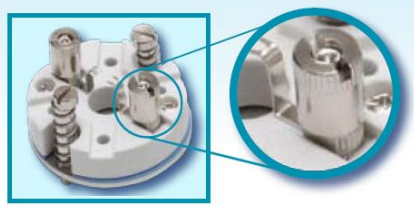

33mm Fixations de 33mm pour accompagner les têtes de raccordement avec code d'identification

Part No.	Poles	Matériel
BOR-D-2P-C	2	45%Al203
BOR-D-3P-C	3	45%Al203
BOR-D-4P-C	4	45%Al203
BOR-D-6P-C	6	45%Al203
BOR-D-8P-C	8	45%Al203

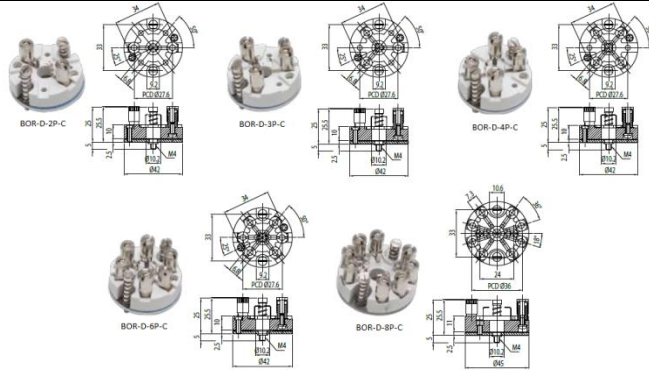

Bornier de type D

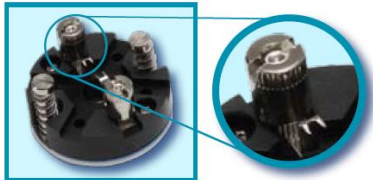

33mm Fixations de 33mm pour accompagner les têtes de raccordement avec code d'identification

Part No.	Poles	Matériel
BOR-D-2P-B	2	Bakélite
BOR-D-3P-B	3	Bakélite
BOR-D-4P-B	4	Bakélite
BOR-D-6P-B	6	Bakélite

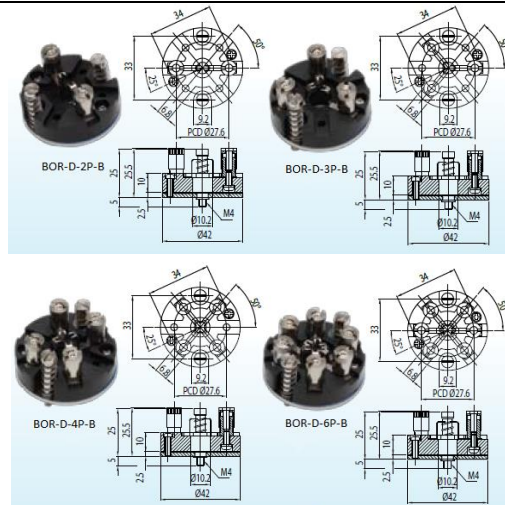

DS Series

Bornier de type DS



33mm Fixations de 33mm pour accompagner les têtes de raccordement avec code d'identification

Part No.	Poles	Matériel
BOR-DS-2P-B	2	Bakélite
BOR-DS-3P-B	3	Bakélite
BOR-DS-4P-B	4	Bakélite
BOR-DS-6P-B	6	Bakélite

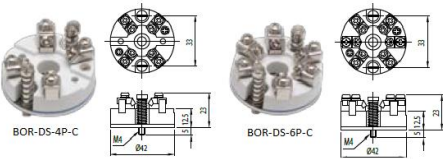
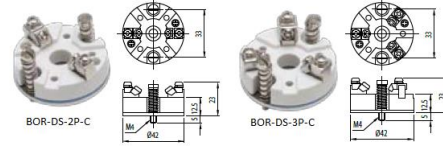

Bornier de type DS



33mm Fixations de 33mm pour accompagner les têtes de raccordement avec code d'identification

Part No.	Poles	Matériel
BOR-DS-2P-B	2	Bakélite
BOR-DS-3P-B	3	Bakélite
BOR-DS-4P-B	4	Bakélite
BOR-DS-6P-B	6	Bakélite

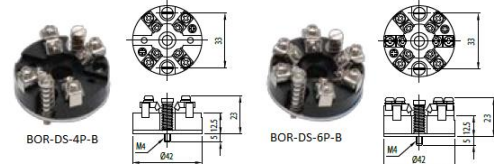
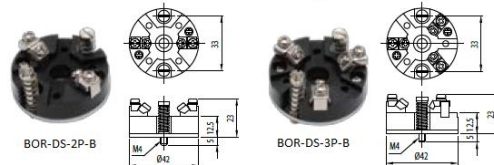

S Series

Bornier de type S



27mm Fixations de 27mm pour accompagner les têtes de raccordement avec code d'identification

Part No.	Poles	Matériel
BOR-S-2P-B	2	Bakélite
BOR-S-3P-B	3	Bakélite
BOR-S-3P-B-45	3	Bakélite
BOR-S-4P-B	4	Bakélite

Bornier de type S



27mm Fixations de 27mm pour accompagner les têtes de raccordement avec code d'identification

Part No.	Poles	Matériel
BOR-S-2P-C	2	45%Al203
BOR-S-3P-C	3	45%Al203
BOR-S-3P-C-45	3	45%Al203
BOR-S-4P-C	4	45%Al203

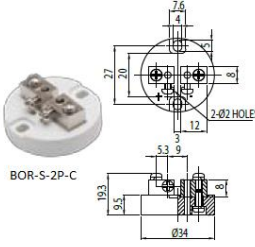
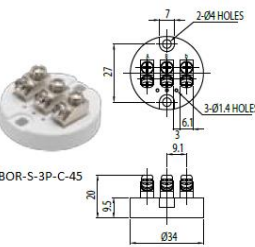
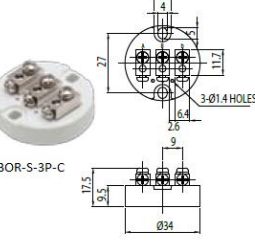
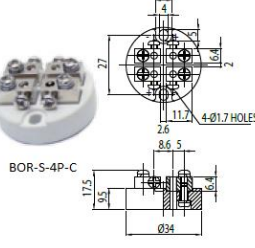
MA Series

Bornier de type MA



20mm Fixations de 20mm pour accompagner les têtes de raccordement avec code d'identification

Part No.	Poles	Matériel
BOR-MA-2P-C	2	45%Al203
BOR-MA-3P-C	3	45%Al203
BOR-S-4P-C	4	45%Al203

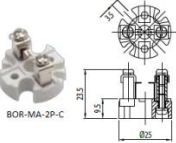
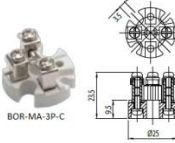
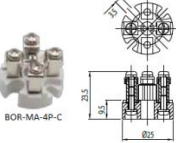
A Series

Bornier de type A

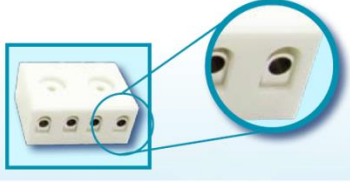

20mm Fixations de 20mm pour accompagner les têtes de raccordement avec code d'identification

Part No.	Poles	Matériel
BOR-A-2P-C	2	45%Al203
BOR-A-3P-C	3	45%Al203
BOR-A-4P-C	4	45%Al203

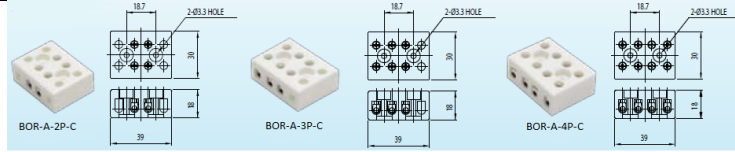

BOR-A-2P-C

BOR-A-3P-C

BOR-A-4P-C

Accessoires

Bornes terminales

Part No.	Description
BOR-TP	Borne terminale

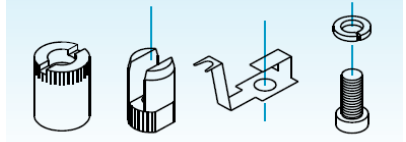

Kit de montage



Kit de montage MK-6



Part No.	Description
BOR-MK-P	Kit de montage

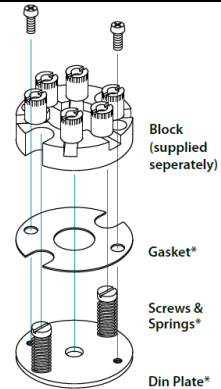

Block
(supplied
seperately)

Gasket*

Screws &
Springs*

Din Plate*

CONTACT

MESUREX

13 Rue des Corroyés
78730 Saint Arnoult en Yvelines

Tel : +33 (0) 1 30 41 23 62

Fax : +33 (0) 1 30 41 23 80

Mail : mesurex@mesurex.fr